

4

3

2

1

Model Number	Voltage	Wattage	Phase	"A" Dim	"B" Dim	"C" FNPT	"D" Dim	"E1" Dim	"E2" Dim	"F" Dim	REVISIONS			
											REV	DESCRIPTIONS	DATE	APPD
BETA-MEP-48720	480	72,000	3	40	4	2	3.25	3	2.875	1.5				

B

B

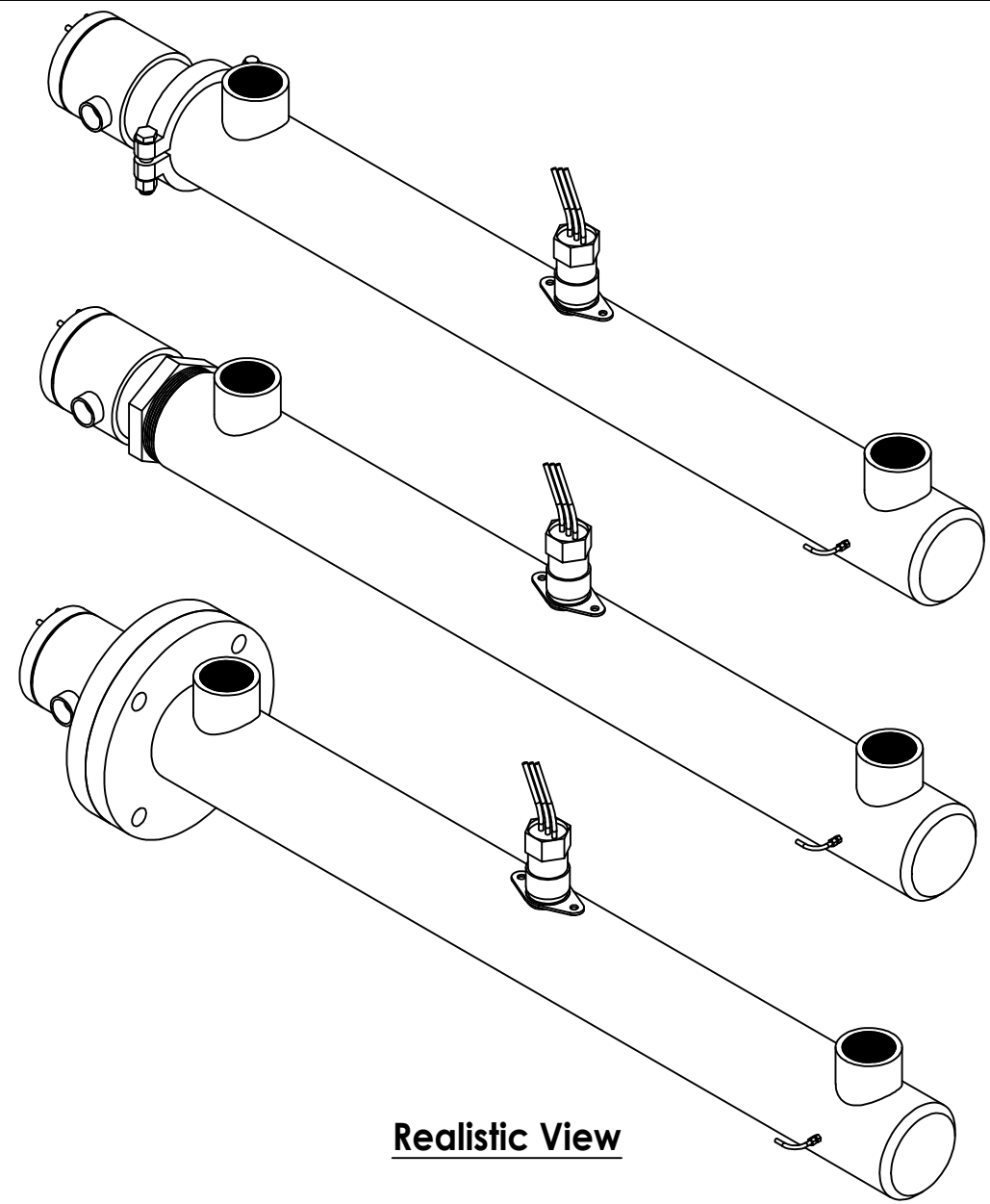
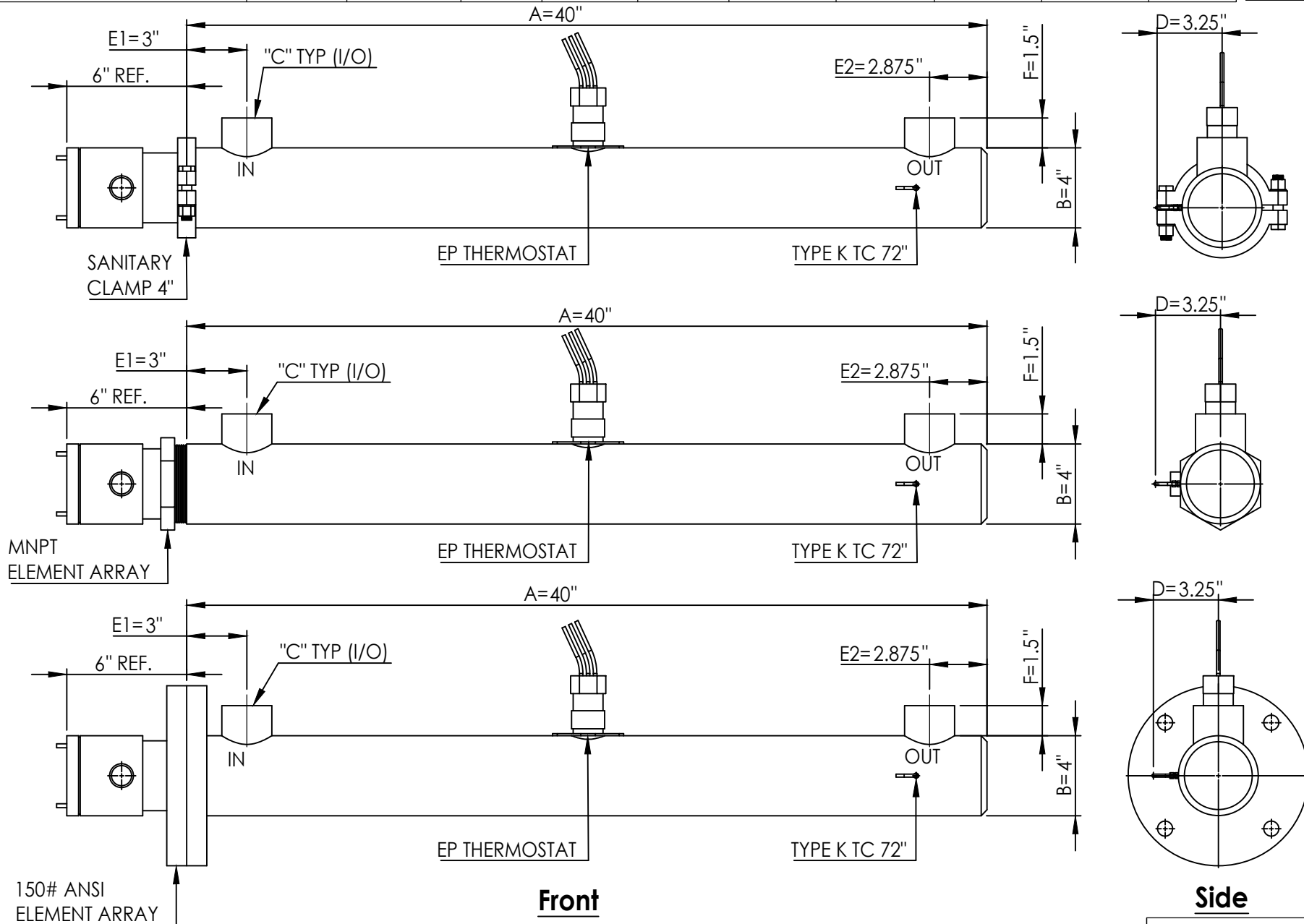

Realistic View

A

A

Unless otherwise specified drawing should be used for estimation purposes only



BETADYNE INDUSTRIES

306 Sturbridge Rd
Charlton MA 01507

PROPRIETARY

TOLERANCES

- XXX +/- 1.0
- XX.X +/- 0.1"
- X.XX +/- 0.05"
- .XXX +/- 0.01"

Drawn By	HEG
Date	06-04-22
Approval	JJ
Revision	0

BETA-MEP

B	BETA-MEP-48720	0
NTS	48720	SHEET 1 OF 1

Notice: THIS DOCUMENT EMBODIES CONFIDENTIAL PROPRIETARY INFORMATION OWNED BY BETADYNE INDUSTRIES. NOTICE IS GIVEN, THAT ALL DESIGN, MANUFACTURING AND REPRODUCTION OR USE OF THIS DOCUMENT IN CONJUNCTION WITH GOVERNMENT CONTRACT OR COMMERCIAL USE DOES NOT CONVEY ANY RIGHTS TO GOVERNMENT PARTIES OR ANY OTHER INTERESTS, AND ITS BRANCHES. ALL DESIGNS AND INFORMATION REMAIN THE SOLE PROPERTY OF BETADYNE INDUSTRIES WITHOUT EXCEPTION. ALL ORDERS BASED ON THIS EMBODIMENT ARE UNDER CONFIDENTIAL AGREEMENT AND CANNOT BE DISCLOSED WITHOUT PRIOR WRITTEN CONSENT TO UNAUTHORIZED PERSONS, OR TO INCORPORATE THIS PROPRIETARY DESIGN AND SUBSTANCE OF IT EITHER IN WHOLE OR IN PART WITH ANY OTHER PROJECT OR PARTIES.

4

3

2

1