

Model Number	Voltage	Wattage	Phase	"A" Dim	"B" Dim	"C" Dim	"D" Dim
BETA-PS-481200	480	120000	3	40	4	1.5" SANITARY	34

REVISIONS			
REV	DESCRIPTIONS	DATE	APPD

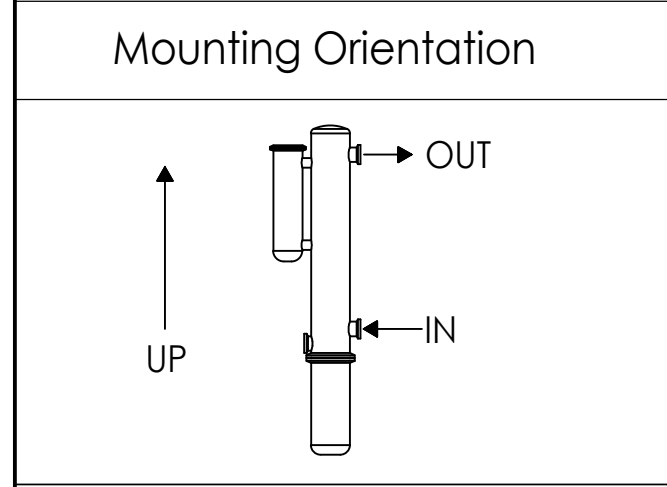
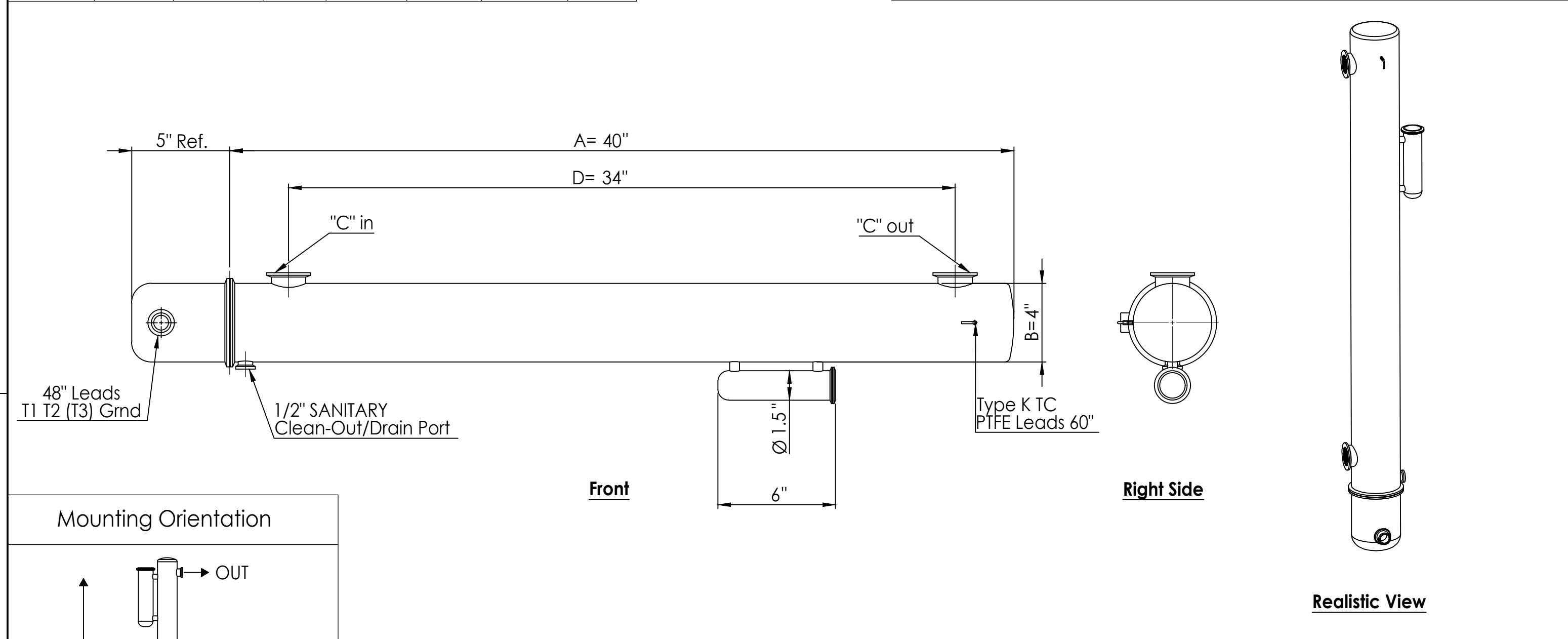

PROPRIETARY

Notice: THIS DOCUMENT EMBODIES CONFIDENTIAL PROPRIETARY INFORMATION OWNED BY BETADYNE INDUSTRIES. NOTICE IS GIVEN, THAT ALL DESIGN, MANUFACTURING AND REPRODUCTION OR USE OF THIS DOCUMENT IN CONJUNCTION WITH GOVERNMENT CONTRACT OR COMMERCIAL USE DOES NOT CONVEY ANY RIGHTS TO GOVERNMENT PARTIES OR ANY OTHER INTERESTS, AND ITS BRANCHES. ALL DESIGNS AND INFORMATION REMAIN THE SOLE PROPERTY OF BETADYNE INDUSTRIES WITHOUT EXCEPTION. ALL ORDERS BASED ON THIS EMBODIMENT ARE UNDER CONFIDENTIAL AGREEMENT AND CANNOT BE DISCLOSED WITHOUT PRIOR WRITTEN CONSENT TO UNAUTHORIZED PERSONS, OR TO INCORPORATE THIS PROPRIETARY DESIGN AND SUBSTANCE OF IT EITHER IN WHOLE OR IN PART WITH ANY OTHER PROJECT OR PARTIES.

TOLERANCES

XXX	+/-	1.0
XX.X	+/-	0.1"
X.XX	+/-	0.05"
.XXX	+/-	0.01"

Unless otherwise specified drawing should be used for estimation purposes only

Drawn By	HEG
Date	12-07-21
Approval	JJ
Revision	0

BETADYNE INDUSTRIES
 306 Sturbridge Rd
 Charlton MA 01507

BETA PURE STEAM GENERATOR

B	BETA-PS-481200	0
NTS	481200	SHEET 1 OF 1