

4

3

2

1

Model Number	Voltage	Wattage	Phase	"A" Dim	"B" Dim	"C" FNPT	"D" Dim	"E1" Dim	"E2" Dim	"F" Dim
BETA-SEP-48060	480	6000	3	24	3	1/2	2.75	3	1	0.75

REVISIONS			
REV	DESCRIPTIONS	DATE	APPD

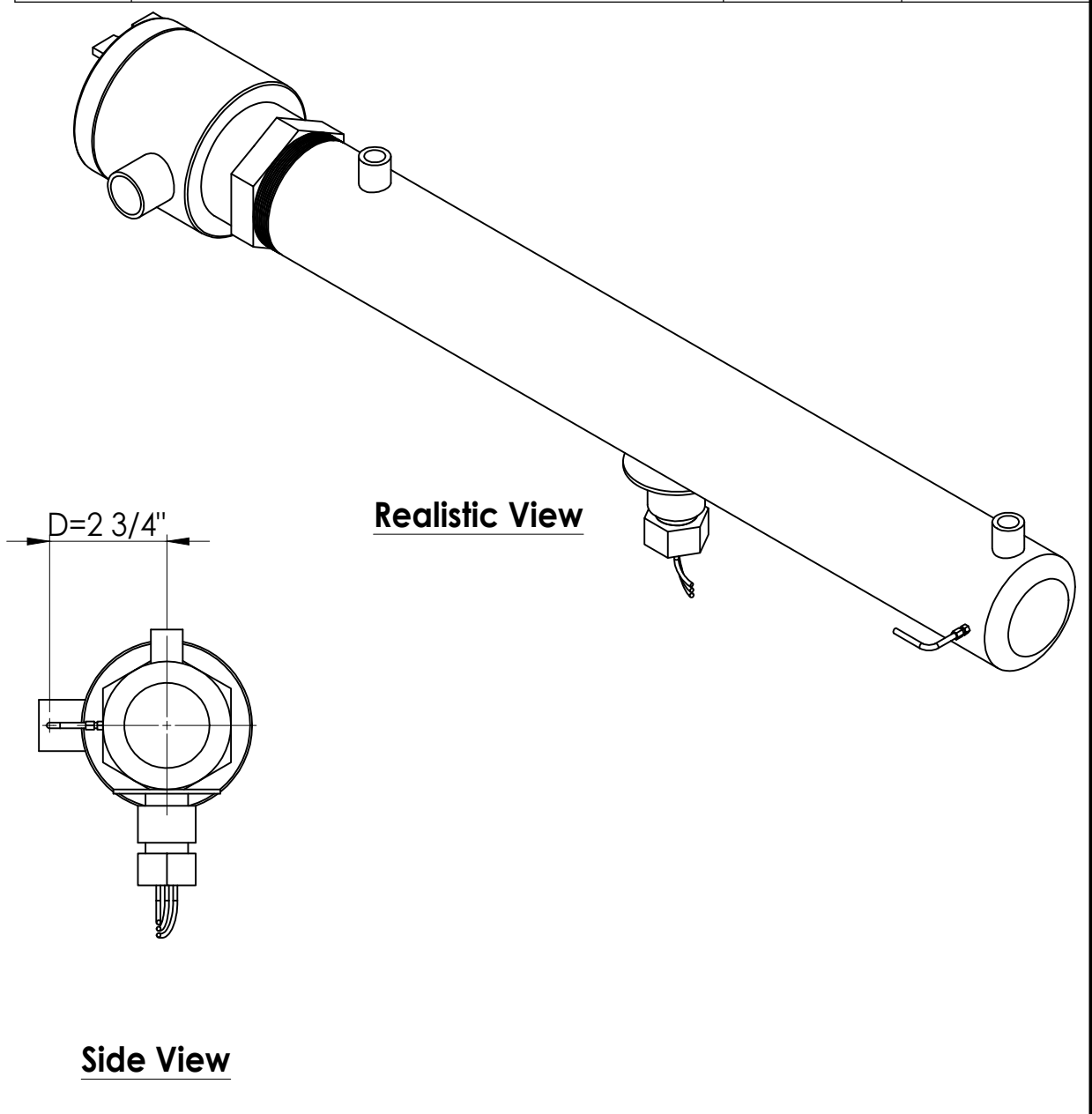
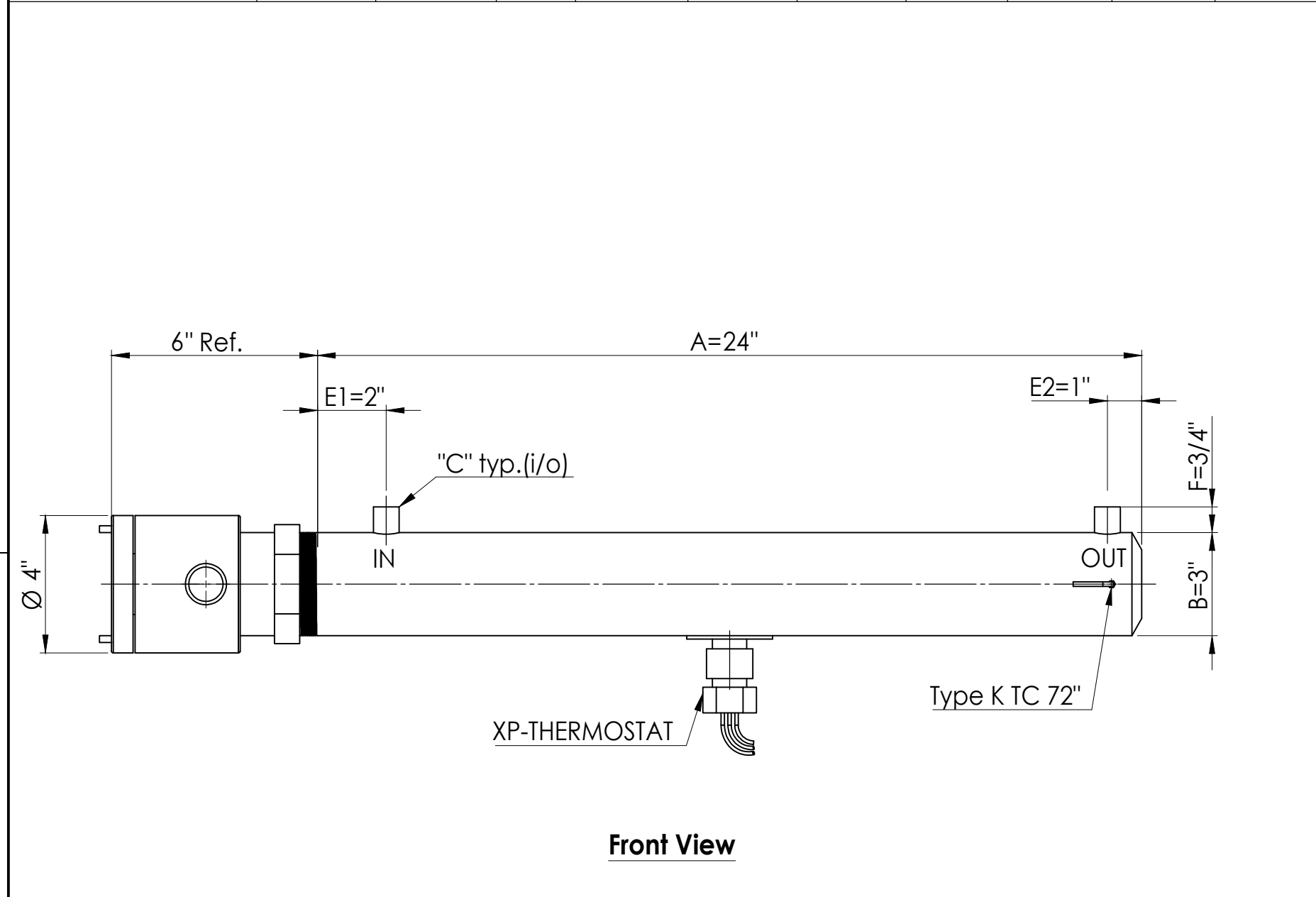

PROPRIETARY

TOLERANCES

Unless otherwise specified drawing should be used for estimation purposes only

BETADYNE INDUSTRIES

BETADYNE INDUSTRIES
306 Sturbridge Rd
Charlton MA 01507

Notice: THIS DOCUMENT EMBODIES CONFIDENTIAL PROPRIETARY INFORMATION OWNED BY BETADYNE INDUSTRIES. NOTICE IS GIVEN, THAT ALL DESIGN, MANUFACTURING AND REPRODUCTION OR USE OF THIS DOCUMENT IN CONJUNCTION WITH GOVERNMENT CONTRACT OR COMMERCIAL USE DOES NOT CONVEY ANY RIGHTS TO GOVERNMENT PARTIES OR ANY OTHER INTERESTS, AND ITS BRANCHES. ALL DESIGNS AND INFORMATION REMAIN THE SOLE PROPERTY OF BETADYNE INDUSTRIES WITHOUT EXCEPTION. ALL ORDERS BASED ON THIS EMBODIMENT ARE UNDER CONFIDENTIAL AGREEMENT AND CANNOT BE DISCLOSED WITHOUT PRIOR WRITTEN CONSENT TO UNAUTHORIZED PERSONS, OR TO INCORPORATE THIS PROPRIETARY DESIGN AND SUBSTANCE OF IT EITHER IN WHOLE OR IN PART WITH ANY OTHER PROJECT OR PARTIES.

XXX +/- 1.0
XX.X +/- 0.1"
X.XX +/- 0.05"
.XXX +/- 0.01"

Drawn By	HEG
Date	01-03-22
Approval	JJ
Revision	0

WATER HEATER SYSTEM

B	BETA-SEP-48060	0
NTS	48060	SHEET 1 OF 1

4

3

2

1